



**ELEVATOR CENTER
OPENING AUTOMATIC DOOR**

6 PANEL

SOLID



Goods Lift, Car Lift & Freight

Complete Elevator & Elevator Spares Solution Under One Roof

6 PANEL CENTER OPENING AUTODOOR FOR CAR



The 6-panel elevator auto door is a robust and reliable solution specifically designed for heavy-duty applications such as goods lifts and car lifts. Engineered to handle large loads, the door features a reinforced structure and smooth automated operation that ensures safe, efficient movement of bulky or heavy items. The 6-panel design allows for wider openings, accommodating vehicles and oversized goods with ease, while advanced safety sensors ensure the door responds quickly to any obstructions. Built to withstand high traffic and rigorous use, this auto door system enhances the functionality and durability of industrial lifting solutions.

Center Opening Automatic Door CAR (6-Panel)

SR NO.	CLEAR OPENING	A	B	C	D	E	F	G
1	2100 MM	2140 MM	2900 MM	2700 MM	2240 MM	150 MM	205 MM	180 MM
2	2200 MM	2240 MM	3033 MM	2700 MM	2240 MM	150 MM	205 MM	180 MM
3	2300 MM	2340 MM	3166 MM	2700 MM	2240 MM	150 MM	205 MM	180 MM
4	2400 MM	2440 MM	3300 MM	2700 MM	2240 MM	150 MM	205 MM	180 MM
5	2500 MM	2540 MM	3433 MM	2700 MM	2240 MM	150 MM	205 MM	180 MM
6	2600 MM	2640 MM	3566 MM	2700 MM	2240 MM	150 MM	205 MM	180 MM
7	2700 MM	2740 MM	3700 MM	2700 MM	2240 MM	150 MM	205 MM	180 MM
8	2800 MM	2840 MM	3833 MM	2700 MM	2240 MM	150 MM	205 MM	180 MM
9	2900 MM	2940 MM	3966 MM	2700 MM	2240 MM	150 MM	205 MM	180 MM
10	3000 MM	3040 MM	4100 MM	2700 MM	2240 MM	150 MM	205 MM	180 MM
11	3100 MM	3140 MM	4233 MM	2700 MM	2240 MM	150 MM	205 MM	180 MM
12	3200 MM	3240 MM	4366 MM	2700 MM	2240 MM	150 MM	205 MM	180 MM
13	3300 MM	3340 MM	4500 MM	2700 MM	2240 MM	150 MM	205 MM	180 MM
14	3400 MM	3440 MM	4633 MM	2700 MM	2240 MM	150 MM	205 MM	180 MM
15	3500 MM	3540 MM	4766 MM	2700 MM	2240 MM	150 MM	205 MM	180 MM
16	3600 MM	3640 MM	4900 MM	2700 MM	2240 MM	150 MM	205 MM	180 MM
17	3700 MM	3740 MM	5033 MM	2700 MM	2240 MM	150 MM	205 MM	180 MM
18	3800 MM	3840 MM	5166 MM	2700 MM	2240 MM	150 MM	205 MM	180 MM
19	3900 MM	3940 MM	5300 MM	2700 MM	2240 MM	150 MM	205 MM	180 MM
20	4000 MM	4040 MM	5433 MM	2700 MM	2240 MM	150 MM	205 MM	180 MM

*All dimensions of drawing are in "mm"

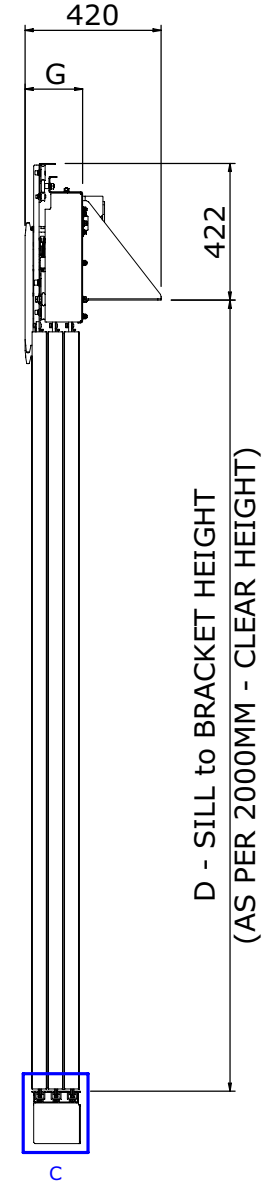
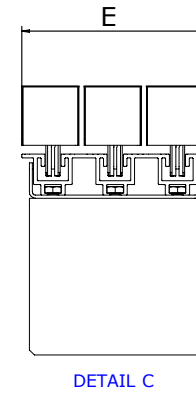
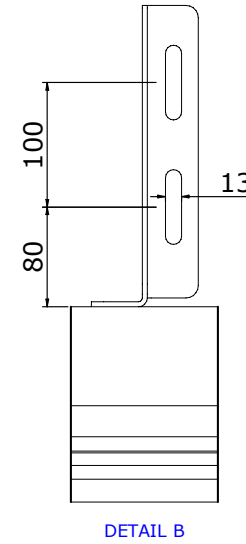
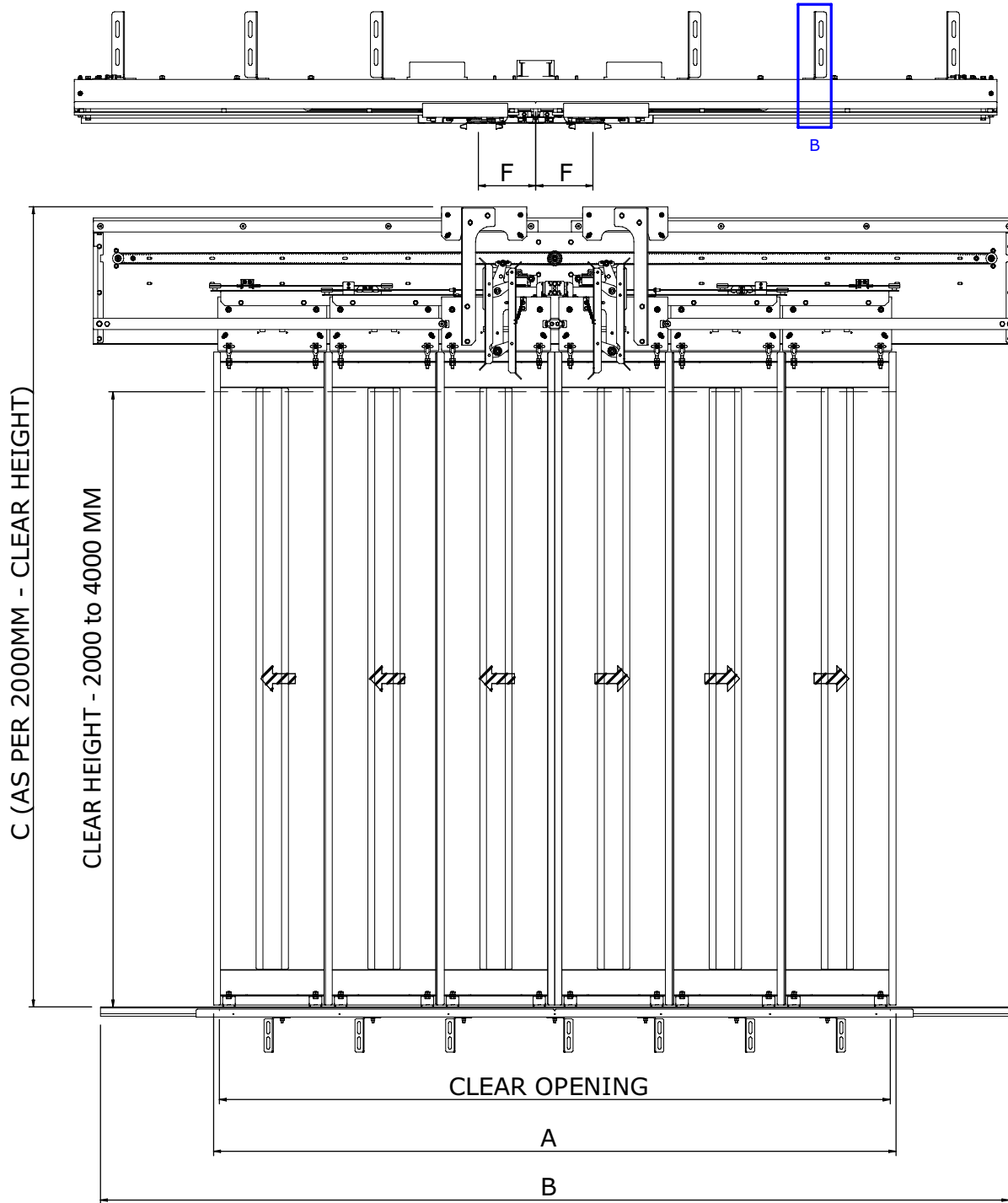

6 PANEL CENTER OPENING AUTODOOR FOR LANDING



Advantage:

- Heavy duty structure for goods & freight elevator
- Using sheet metal form body, for good loading effect
- Low noise, smooth operation, low maintenance & eco-friendly
- More compact design for compact well
- Large torque & energy saving
- Encoder build vvvf frequency controller with motor for high accuracy
- Auto reset & power cut protection

Center Opening Automatic Door LANDING (6-Panel)

SR NO.	CLEAR OPENING	A	B	C	D	E	F
1	2100 MM	2800 MM	2900 MM	2425 MM	210 MM	150 MM	230 MM
2	2200 MM	2380 MM	3033 MM	2425 MM	210 MM	150 MM	230 MM
3	2300 MM	2480 MM	3166 MM	2425 MM	210 MM	150 MM	230 MM
4	2400 MM	2580 MM	3300 MM	2425 MM	210 MM	150 MM	230 MM
5	2500 MM	2680 MM	3433 MM	2425 MM	210 MM	150 MM	230 MM
6	2600 MM	2780 MM	3566 MM	2425 MM	210 MM	150 MM	230 MM
7	2700 MM	2880 MM	3700 MM	2425 MM	210 MM	150 MM	230 MM
8	2800 MM	2980 MM	3833 MM	2425 MM	210 MM	150 MM	230 MM
9	2900 MM	3080 MM	3966 MM	2425 MM	210 MM	150 MM	230 MM
10	3000 MM	3180 MM	4100 MM	2425 MM	210 MM	150 MM	230 MM
11	3100 MM	3280 MM	4233 MM	2425 MM	210 MM	150 MM	230 MM
12	3200 MM	3380 MM	4366 MM	2425 MM	210 MM	150 MM	230 MM
13	3300 MM	3480 MM	4500 MM	2425 MM	210 MM	150 MM	230 MM
14	3400 MM	3580 MM	4633 MM	2425 MM	210 MM	150 MM	230 MM
15	3500 MM	3680 MM	4766 MM	2425 MM	210 MM	150 MM	230 MM
16	3600 MM	3780 MM	4900 MM	2425 MM	210 MM	150 MM	230 MM
17	3700 MM	3880 MM	5033 MM	2425 MM	210 MM	150 MM	230 MM
18	3800 MM	3980 MM	5166 MM	2425 MM	210 MM	150 MM	230 MM
19	3900 MM	4080 MM	5300 MM	2425 MM	210 MM	150 MM	230 MM
20	4000 MM	4180 MM	5433 MM	2425 MM	210 MM	150 MM	230 MM

*All dimensions of drawing are in "mm"

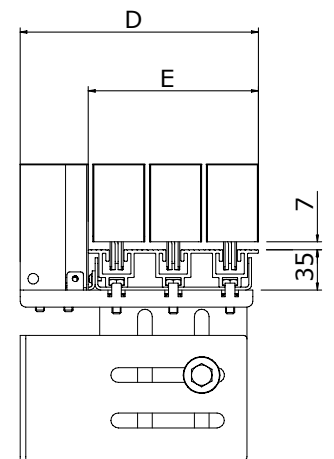
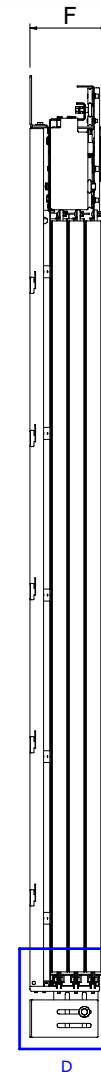
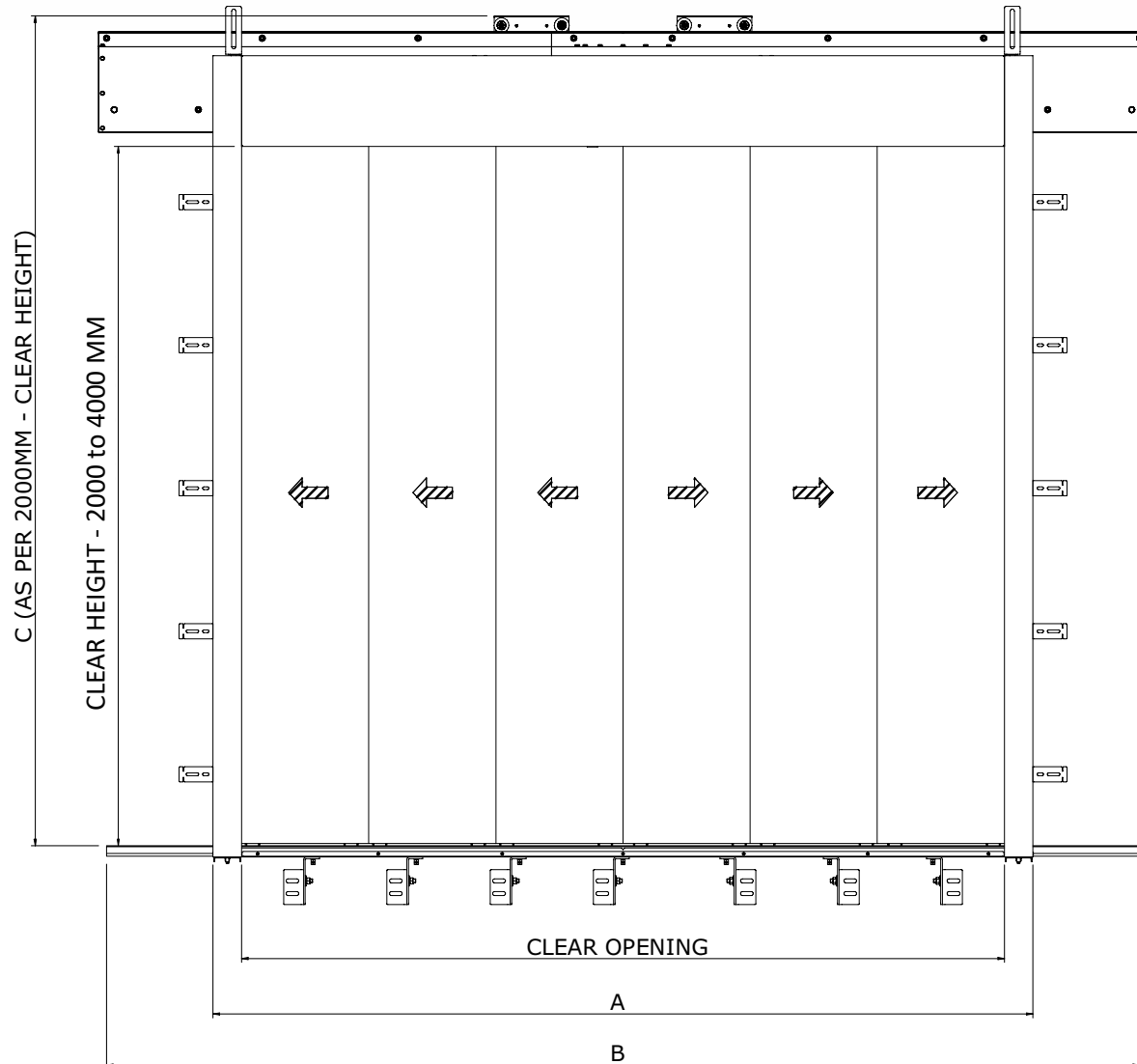
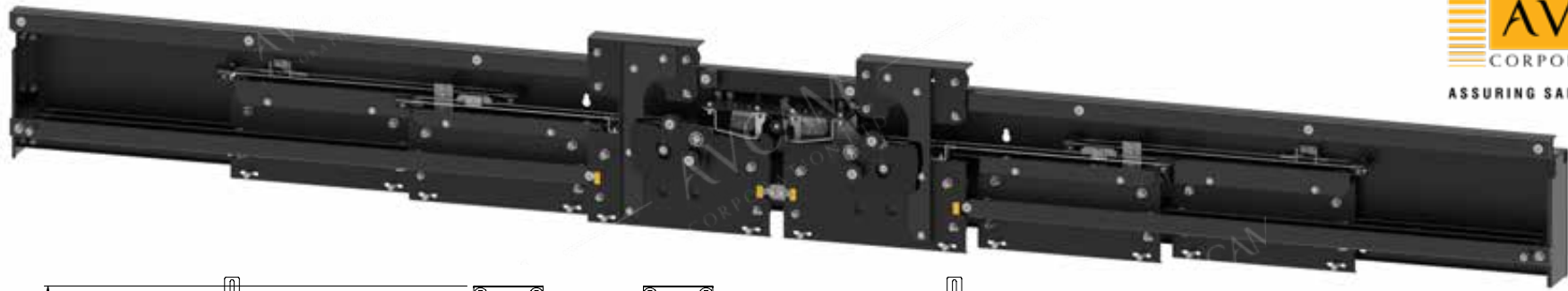

DETAIL D







Manufacturing Plant & Office

Survey No. 503, Majara-Talod Road,
Gujarat State Highway 143, Taluka: Prantij
Opp. Kashtabhanjan Petroleum (NAYARA Petrol Pump),
Dist. Sabarkantha, Ghadkan, Gujarat 383 205.



Location Map

- ✉ info@avcamcorporation.com
- 🌐 www.avcamcorporation.com
- ☎ +91 98250 19838, +91 97651 66169

Our Virtual Presence



website



facebook



twitter



pinterest



linkedin



instgram



youtube



whatsapp

Disclaimer : The data contained within this catalogue is subject to change, errors and printing errors; any liability is excluded. Technical data in particular is subject to change without prior notification. Images are not exact and may contain minor deviations from the original. Unauthorized reproduction or distribution of photos or technical data is prohibited and may result in legal action.